

Mincost Flow

Problem Definition:

$$\begin{aligned} \min \quad & \sum_e c(e)f(e) \\ \text{s.t.} \quad & \forall e \in E: 0 \leq f(e) \leq u(e) \\ & \forall v \in V: f(v) = b(v) \end{aligned}$$

Problem Definition:

$$\begin{aligned} \min \quad & \sum_e c(e)f(e) \\ \text{s.t.} \quad & \forall e \in E: 0 \leq f(e) \leq u(e) \\ & \forall v \in V: f(v) = b(v) \end{aligned}$$

- ▶ $G = (V, E)$ is a **directed graph**.

Problem Definition:

$$\begin{aligned} \min \quad & \sum_e c(e)f(e) \\ \text{s.t.} \quad & \forall e \in E: 0 \leq f(e) \leq u(e) \\ & \forall v \in V: f(v) = b(v) \end{aligned}$$

- ▶ $G = (V, E)$ is a **directed graph**.
- ▶ $u : E \rightarrow \mathbb{R}_0^+ \cup \{\infty\}$ is the **capacity function**.

Problem Definition:

$$\begin{aligned} \min \quad & \sum_e c(e)f(e) \\ \text{s.t.} \quad & \forall e \in E: 0 \leq f(e) \leq u(e) \\ & \forall v \in V: f(v) = b(v) \end{aligned}$$

- ▶ $G = (V, E)$ is a **directed graph**.
- ▶ $u : E \rightarrow \mathbb{R}_0^+ \cup \{\infty\}$ is the **capacity function**.
- ▶ $c : E \rightarrow \mathbb{R}$ is the **cost function**
(note that $c(e)$ may be negative).

Problem Definition:

$$\begin{aligned} \min \quad & \sum_e c(e)f(e) \\ \text{s.t.} \quad & \forall e \in E: 0 \leq f(e) \leq u(e) \\ & \forall v \in V: f(v) = b(v) \end{aligned}$$

- ▶ $G = (V, E)$ is a **directed graph**.
- ▶ $u : E \rightarrow \mathbb{R}_0^+ \cup \{\infty\}$ is the **capacity function**.
- ▶ $c : E \rightarrow \mathbb{R}$ is the **cost function**
(note that $c(e)$ may be negative).
- ▶ $b : V \rightarrow \mathbb{R}, \sum_{v \in V} b(v) = 0$ is a **demand function**.

Solve Maxflow Using Mincost Flow

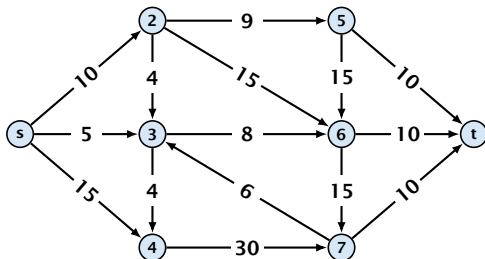

Solve Maxflow Using Mincost Flow

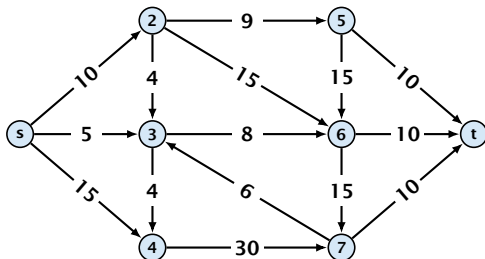

- ▶ Given a flow network for a standard maxflow problem.

Solve Maxflow Using Mincost Flow

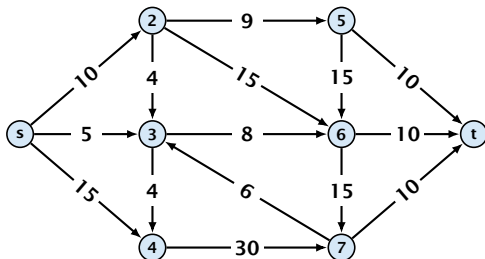

- ▶ Given a flow network for a standard maxflow problem.
- ▶ Set $b(v) = 0$ for every node. Keep the capacity function u for all edges. Set the cost $c(e)$ for every edge to 0.

Solve Maxflow Using Mincost Flow

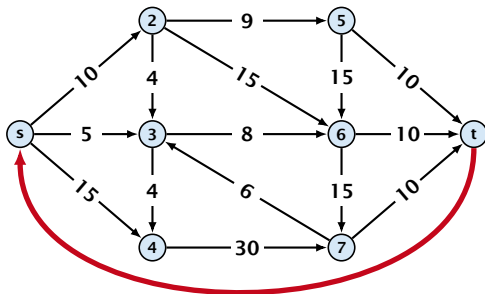

- ▶ Given a flow network for a standard maxflow problem.
- ▶ Set $b(v) = 0$ for every node. Keep the capacity function u for all edges. Set the cost $c(e)$ for every edge to 0.
- ▶ Add an edge from t to s with infinite capacity and cost -1 .

Solve Maxflow Using Mincost Flow

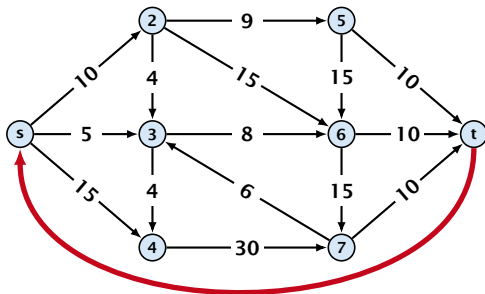

- ▶ Given a flow network for a standard maxflow problem.
- ▶ Set $b(v) = 0$ for every node. Keep the capacity function u for all edges. Set the cost $c(e)$ for every edge to 0.
- ▶ Add an edge from t to s with infinite capacity and cost -1 .
- ▶ Then, $\text{val}(f^*) = -\text{cost}(f_{\min})$, where f^* is a maxflow, and f_{\min} is a mincost-flow.

Solve Maxflow Using Mincost Flow

Solve decision version of maxflow:

- ▶ Given a flow network for a standard maxflow problem, and a value k .

Solve Maxflow Using Mincost Flow

Solve decision version of maxflow:

- ▶ Given a flow network for a standard maxflow problem, and a value k .
- ▶ Set $b(v) = 0$ for every node apart from s or t . Set $b(s) = -k$ and $b(t) = k$.

Solve Maxflow Using Mincost Flow

Solve decision version of maxflow:

- ▶ Given a flow network for a standard maxflow problem, and a value k .
- ▶ Set $b(v) = 0$ for every node apart from s or t . Set $b(s) = -k$ and $b(t) = k$.
- ▶ Set edge-costs to zero, and keep the capacities.

Solve Maxflow Using Mincost Flow

Solve decision version of maxflow:

- ▶ Given a flow network for a standard maxflow problem, and a value k .
- ▶ Set $b(v) = 0$ for every node apart from s or t . Set $b(s) = -k$ and $b(t) = k$.
- ▶ Set edge-costs to zero, and keep the capacities.
- ▶ There exists a maxflow of value at least k if and only if the mincost-flow problem is feasible.

Generalization

Our model:

$$\begin{aligned} \min \quad & \sum_e c(e) f(e) \\ \text{s.t.} \quad & \forall e \in E: 0 \leq f(e) \leq u(e) \\ & \forall v \in V: f(v) = b(v) \end{aligned}$$

where $b : V \rightarrow \mathbb{R}$, $\sum_v b(v) = 0$; $u : E \rightarrow \mathbb{R}_0^+ \cup \{\infty\}$; $c : E \rightarrow \mathbb{R}$;

Generalization

Our model:

$$\begin{aligned} \min \quad & \sum_e c(e)f(e) \\ \text{s.t.} \quad & \forall e \in E: 0 \leq f(e) \leq u(e) \\ & \forall v \in V: f(v) = b(v) \end{aligned}$$

where $b: V \rightarrow \mathbb{R}$, $\sum_v b(v) = 0$; $u: E \rightarrow \mathbb{R}_0^+ \cup \{\infty\}$; $c: E \rightarrow \mathbb{R}$;

A more general model?

$$\begin{aligned} \min \quad & \sum_e c(e)f(e) \\ \text{s.t.} \quad & \forall e \in E: \ell(e) \leq f(e) \leq u(e) \\ & \forall v \in V: a(v) \leq f(v) \leq b(v) \end{aligned}$$

where $a: V \rightarrow \mathbb{R}$, $b: V \rightarrow \mathbb{R}$; $\ell: E \rightarrow \mathbb{R} \cup \{-\infty\}$, $u: E \rightarrow \mathbb{R} \cup \{\infty\}$
 $c: E \rightarrow \mathbb{R}$;

Differences

- ▶ Flow along an edge e may have non-zero lower bound $\ell(e)$.
- ▶ Flow along e may have negative upper bound $u(e)$.
- ▶ The demand at a node v may have lower bound $a(v)$ and upper bound $b(v)$ instead of just lower bound = upper bound = $b(v)$.

Reduction I

$$\begin{aligned} \min \quad & \sum_e c(e)f(e) \\ \text{s.t.} \quad & \forall e \in E: \ell(e) \leq f(e) \leq u(e) \\ & \forall v \in V: a(v) \leq f(v) \leq b(v) \end{aligned}$$

Reduction I

$$\begin{aligned} \min \quad & \sum_e c(e)f(e) \\ \text{s.t.} \quad & \forall e \in E: \ell(e) \leq f(e) \leq u(e) \\ & \forall v \in V: a(v) \leq f(v) \leq b(v) \end{aligned}$$

We can assume that $a(v) = b(v)$:

Reduction I

$$\begin{aligned} \min \quad & \sum_e c(e)f(e) \\ \text{s.t.} \quad & \forall e \in E: \ell(e) \leq f(e) \leq u(e) \\ & \forall v \in V: a(v) \leq f(v) \leq b(v) \end{aligned}$$

We can assume that $a(v) = b(v)$:

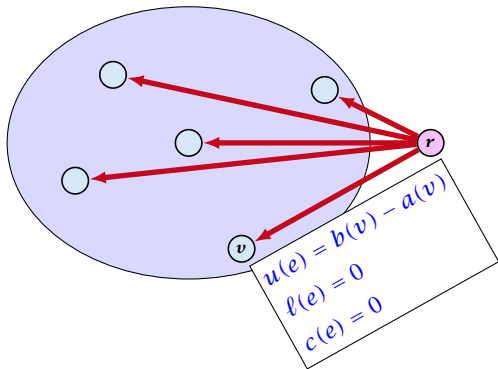

Reduction I

$$\begin{aligned} \min \quad & \sum_e c(e)f(e) \\ \text{s.t.} \quad & \forall e \in E: \ell(e) \leq f(e) \leq u(e) \\ & \forall v \in V: a(v) \leq f(v) \leq b(v) \end{aligned}$$

We can assume that $a(v) = b(v)$:

Add new node r .

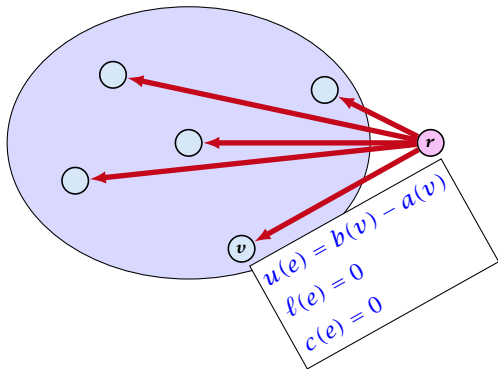

Reduction I

$$\begin{aligned} \min \quad & \sum_e c(e)f(e) \\ \text{s.t.} \quad & \forall e \in E: \ell(e) \leq f(e) \leq u(e) \\ & \forall v \in V: a(v) \leq f(v) \leq b(v) \end{aligned}$$

We can assume that $a(v) = b(v)$:

Add new node r .

Add edge (r, v) for all $v \in V$.

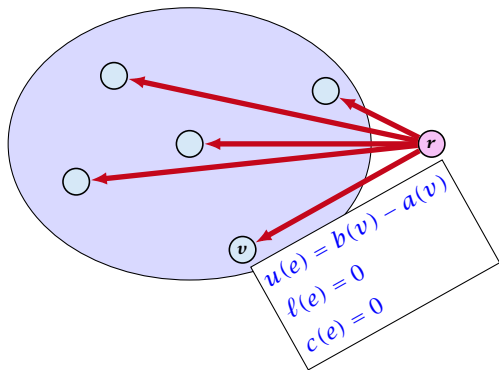

Reduction I

$$\begin{aligned} \min \quad & \sum_e c(e)f(e) \\ \text{s.t.} \quad & \forall e \in E: \ell(e) \leq f(e) \leq u(e) \\ & \forall v \in V: a(v) \leq f(v) \leq b(v) \end{aligned}$$

We can assume that $a(v) = b(v)$:

Add new node r .

Add edge (r, v) for all $v \in V$.

Set $\ell(e) = c(e) = 0$ for these edges.

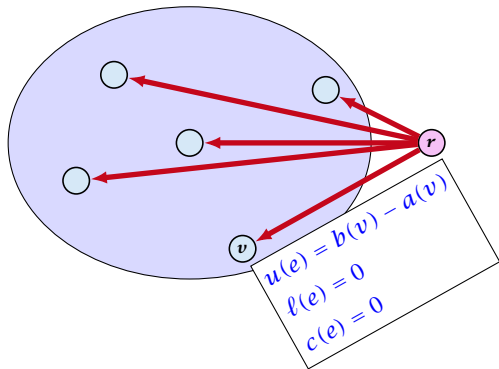

Reduction I

$$\begin{aligned} \min \quad & \sum_e c(e)f(e) \\ \text{s.t.} \quad & \forall e \in E: \ell(e) \leq f(e) \leq u(e) \\ & \forall v \in V: a(v) \leq f(v) \leq b(v) \end{aligned}$$

We can assume that $a(v) = b(v)$:

Add new node r .

Add edge (r, v) for all $v \in V$.

Set $\ell(e) = c(e) = 0$ for these edges.

Set $u(e) = b(v) - a(v)$ for edge (r, v) .

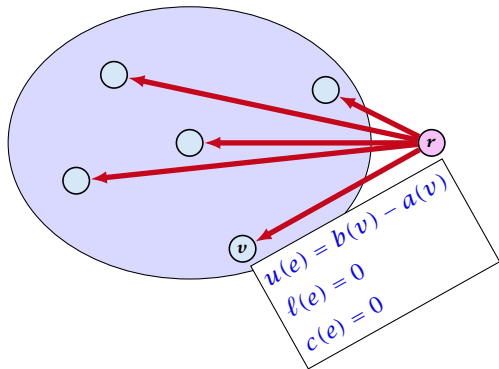

Reduction I

$$\begin{aligned} \min \quad & \sum_e c(e)f(e) \\ \text{s.t.} \quad & \forall e \in E: \ell(e) \leq f(e) \leq u(e) \\ & \forall v \in V: a(v) \leq f(v) \leq b(v) \end{aligned}$$

We can assume that $a(v) = b(v)$:

Add new node r .

Add edge (r, v) for all $v \in V$.

Set $\ell(e) = c(e) = 0$ for these edges.

Set $u(e) = b(v) - a(v)$ for edge (r, v) .

Set $a(v) = b(v)$ for all $v \in V$.

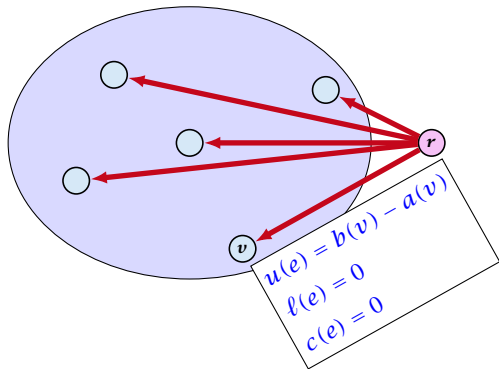

Reduction I

$$\begin{aligned} \min \quad & \sum_e c(e)f(e) \\ \text{s.t.} \quad & \forall e \in E: \ell(e) \leq f(e) \leq u(e) \\ & \forall v \in V: a(v) \leq f(v) \leq b(v) \end{aligned}$$

We can assume that $a(v) = b(v)$:

Add new node r .

Add edge (r, v) for all $v \in V$.

Set $\ell(e) = c(e) = 0$ for these edges.

Set $u(e) = b(v) - a(v)$ for edge (r, v) .

Set $a(v) = b(v)$ for all $v \in V$.

Set $b(r) = -\sum_{v \in V} b(v)$.

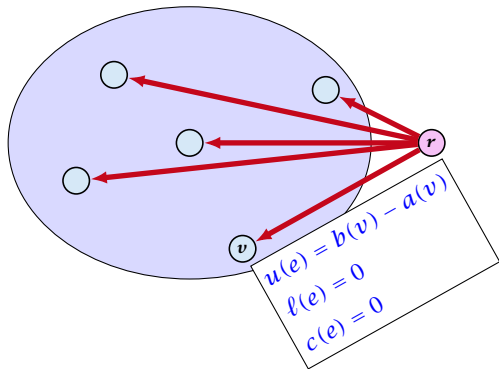

Reduction I

$$\begin{aligned} \min \quad & \sum_e c(e)f(e) \\ \text{s.t.} \quad & \forall e \in E: \ell(e) \leq f(e) \leq u(e) \\ & \forall v \in V: a(v) \leq f(v) \leq b(v) \end{aligned}$$

We can assume that $a(v) = b(v)$:

Add new node r .

Add edge (r, v) for all $v \in V$.

Set $\ell(e) = c(e) = 0$ for these edges.

Set $u(e) = b(v) - a(v)$ for edge (r, v) .

Set $a(v) = b(v)$ for all $v \in V$.

Set $b(r) = -\sum_{v \in V} b(v)$.

$-\sum_v b(v)$ is negative; hence r is only sending flow.

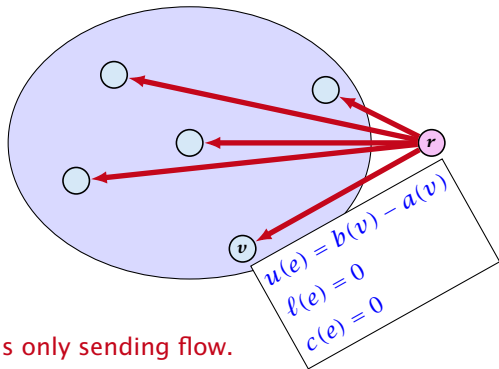

Reduction II

$$\begin{aligned} \min \quad & \sum_e c(e)f(e) \\ \text{s.t.} \quad & \forall e \in E: \ell(e) \leq f(e) \leq u(e) \\ & \forall v \in V: f(v) = b(v) \end{aligned}$$

We can assume that either $\ell(e) \neq -\infty$ or $u(e) \neq \infty$:

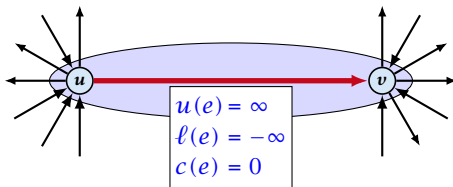

Reduction II

$$\begin{aligned} \min \quad & \sum_e c(e)f(e) \\ \text{s.t.} \quad & \forall e \in E: \ell(e) \leq f(e) \leq u(e) \\ & \forall v \in V: f(v) = b(v) \end{aligned}$$

We can assume that either $\ell(e) \neq -\infty$ or $u(e) \neq \infty$:

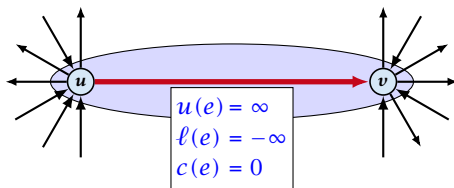

If $c(e) = 0$ we can contract the edge/identify nodes u and v .

Reduction II

$$\begin{aligned} \min \quad & \sum_e c(e)f(e) \\ \text{s.t.} \quad & \forall e \in E: \ell(e) \leq f(e) \leq u(e) \\ & \forall v \in V: f(v) = b(v) \end{aligned}$$

We can assume that either $\ell(e) \neq -\infty$ or $u(e) \neq \infty$:

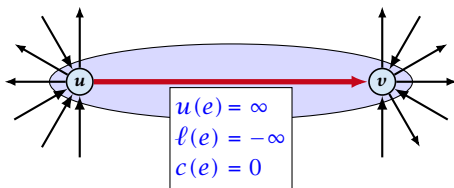

If $c(e) = 0$ we can contract the edge/identify nodes u and v .

If $c(e) \neq 0$ we can transform the graph so that $c(e) = 0$.

Reduction II

We can transform any network so that a particular edge has cost $c(e) = 0$:

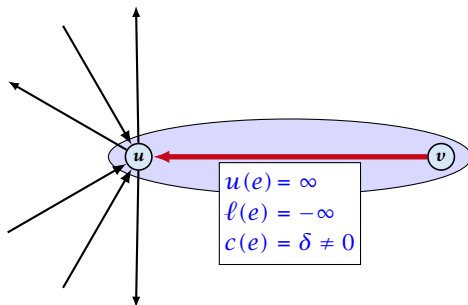

Reduction II

We can transform any network so that a particular edge has cost $c(e) = 0$:

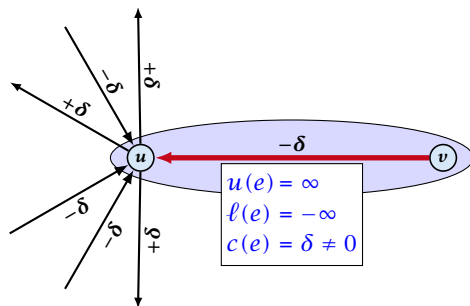

Reduction II

We can transform any network so that a particular edge has cost $c(e) = 0$:

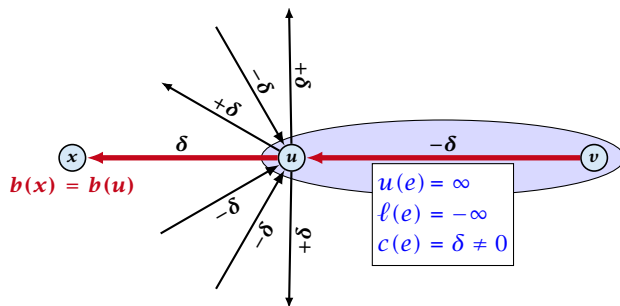

Additionally we set $b(u) = 0$.

Reduction III

$$\begin{aligned} \min \quad & \sum_e c(e)f(e) \\ \text{s.t.} \quad & \forall e \in E: \ell(e) \leq f(e) \leq u(e) \\ & \forall v \in V: f(v) = b(v) \end{aligned}$$

We can assume that $\ell(e) \neq -\infty$:

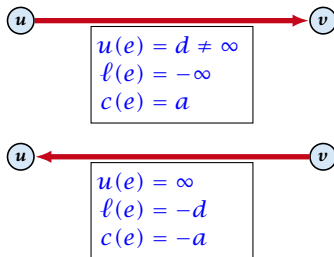

Replace the edge by an edge in opposite direction.

Reduction IV

$$\begin{aligned} \min \quad & \sum_e c(e)f(e) \\ \text{s.t.} \quad & \forall e \in E: \ell(e) \leq f(e) \leq u(e) \\ & \forall v \in V: f(v) = b(v) \end{aligned}$$

We can assume that $\ell(e) = 0$:

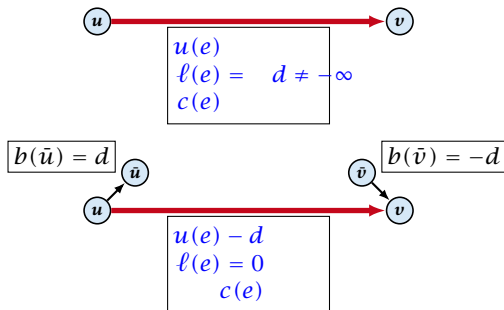

The added edges have infinite capacity and cost $c(e)/2$.

Caterer Problem

- ▶ She needs to supply r_i napkins on N successive days.

Caterer Problem

- ▶ She needs to supply r_i napkins on N successive days.
- ▶ She can buy new napkins at p cents each.

Caterer Problem

- ▶ She needs to supply r_i napkins on N successive days.
- ▶ She can buy new napkins at p cents each.
- ▶ She can launder them at a fast laundry that takes m days and cost f cents a napkin.

Caterer Problem

- ▶ She needs to supply r_i napkins on N successive days.
- ▶ She can buy new napkins at p cents each.
- ▶ She can launder them at a fast laundry that takes m days and cost f cents a napkin.
- ▶ She can use a slow laundry that takes $k > m$ days and costs s cents each.

Caterer Problem

- ▶ She needs to supply r_i napkins on N successive days.
- ▶ She can buy new napkins at p cents each.
- ▶ She can launder them at a fast laundry that takes m days and cost f cents a napkin.
- ▶ She can use a slow laundry that takes $k > m$ days and costs s cents each.
- ▶ At the end of each day she should determine how many to send to each laundry and how many to buy in order to fulfill demand.

Caterer Problem

- ▶ She needs to supply r_i napkins on N successive days.
- ▶ She can buy new napkins at p cents each.
- ▶ She can launder them at a fast laundry that takes m days and cost f cents a napkin.
- ▶ She can use a slow laundry that takes $k > m$ days and costs s cents each.
- ▶ At the end of each day she should determine how many to send to each laundry and how many to buy in order to fulfill demand.
- ▶ Minimize cost.

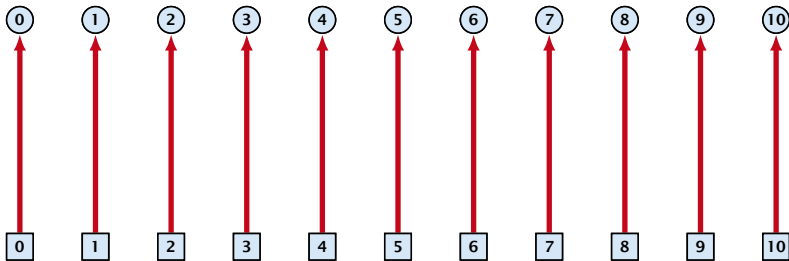

day edges:

upper bound: $u(e_i) = \infty$;
lower bound: $\ell(e_i) = r_i$;
cost: $c(e) = 0$

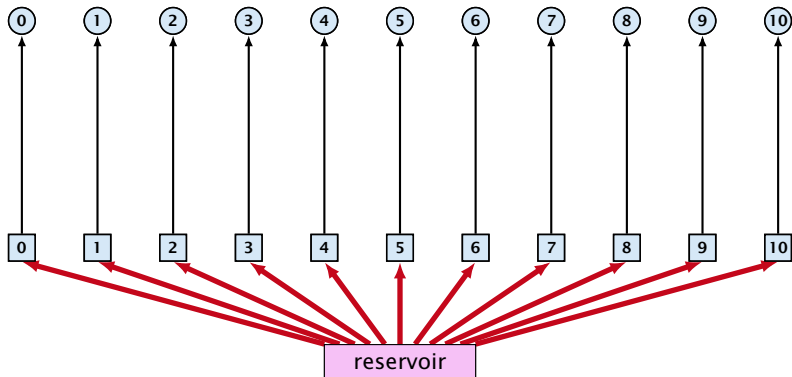

buy edges:

upper bound: $u(e_i) = \infty$;
lower bound: $\ell(e_i) = 0$;
cost: $c(e) = p$

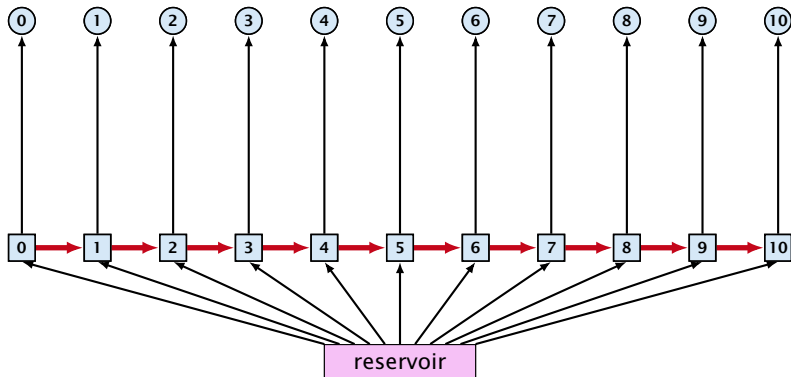

forward edges:

upper bound: $u(e_i) = \infty$;
lower bound: $\ell(e_i) = 0$;
cost: $c(e) = 0$

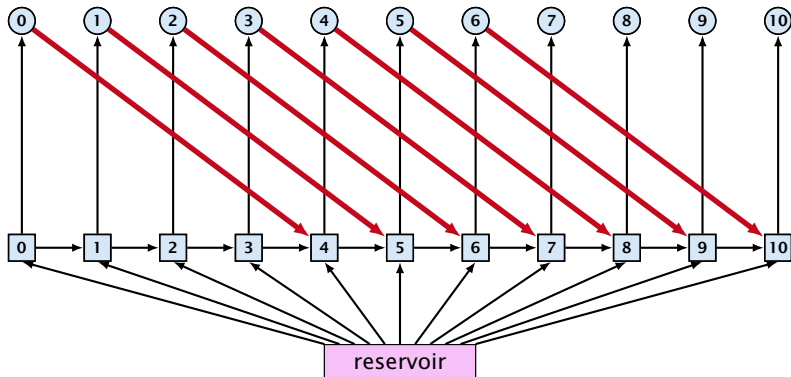

slow edges:

upper bound: $u(e_i) = \infty$;
 lower bound: $\ell(e_i) = 0$;
 cost: $c(e) = s$

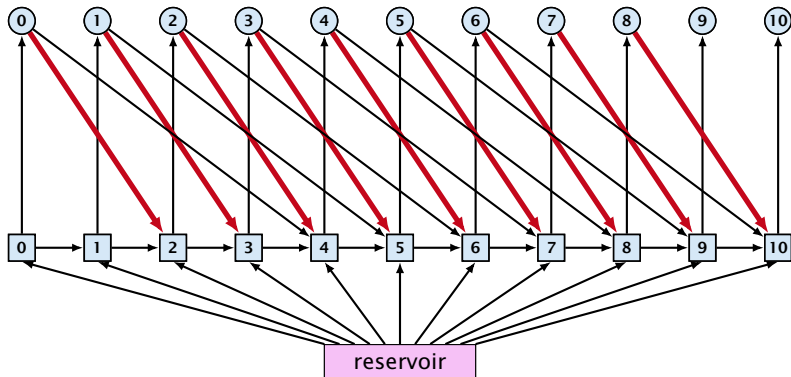

fast edges:

upper bound: $u(e_i) = \infty$;
 lower bound: $\ell(e_i) = 0$;
 cost: $c(e) = f$

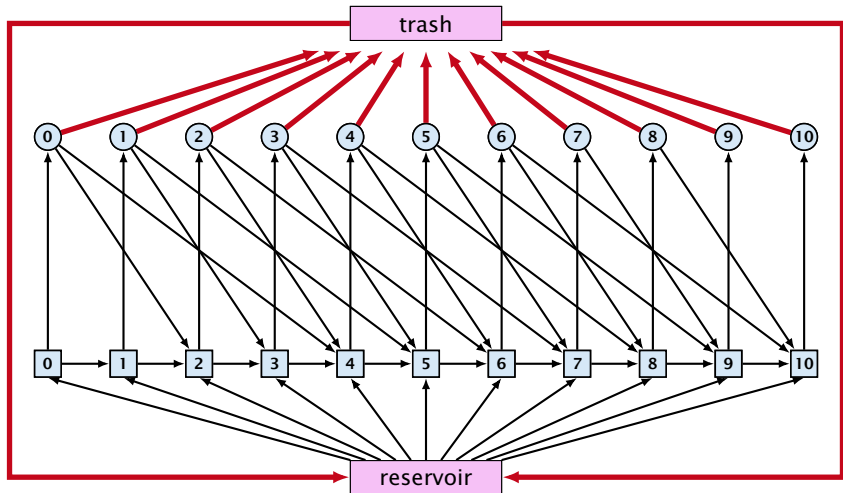

trash edges:

upper bound: $u(e_i) = \infty$;
 lower bound: $\ell(e_i) = 0$;
 cost: $c(e) = 0$

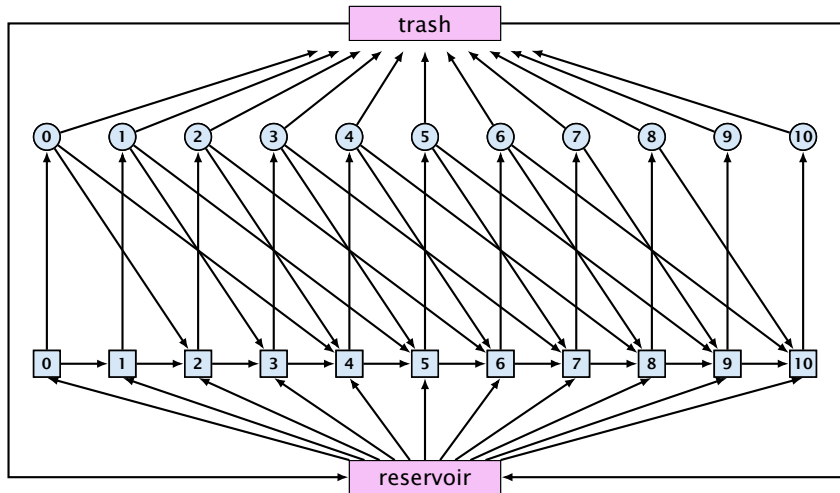

Residual Graph

Version A:

The residual graph G' for a mincost flow is just a copy of the graph G .

If we send $f(e)$ along an edge, the corresponding edge e' in the residual graph has its lower and upper bound changed to $l(e') = l(e) - f(e)$ and $u(e') = u(e) - f(e)$.

Residual Graph

Version A:

The residual graph G' for a mincost flow is just a copy of the graph G .

If we send $f(e)$ along an edge, the corresponding edge e' in the residual graph has its lower and upper bound changed to $l(e') = l(e) - f(e)$ and $u(e') = u(e) - f(e)$.

Version B:

The residual graph for a mincost flow is exactly defined as the residual graph for standard flows, with the only exception that one needs to define a cost for the residual edge.

For a flow of z from u to v the residual edge (v, u) has capacity z and a cost of $-c((u, v))$.

10 Mincost Flow

A **circulation** in a graph $G = (V, E)$ is a function $f : E \rightarrow \mathbb{R}^+$ that has an excess flow $f(v) = 0$ for every node $v \in V$.

10 Mincost Flow

A **circulation** in a graph $G = (V, E)$ is a function $f : E \rightarrow \mathbb{R}^+$ that has an excess flow $f(v) = 0$ for every node $v \in V$.

A circulation is **feasible** if it fulfills capacity constraints, i.e., $f(e) \leq u(e)$ for every edge of G .

Lemma 73

A given flow is a mincost-flow if and only if the corresponding residual graph G_f does not have a feasible circulation of negative cost.

Lemma 73

A given flow is a mincost-flow if and only if the corresponding residual graph G_f does not have a feasible circulation of negative cost.

- ⇒ Suppose that g is a feasible circulation of negative cost in the residual graph.

Lemma 73

A given flow is a mincost-flow if and only if the corresponding residual graph G_f does not have a feasible circulation of negative cost.

⇒ Suppose that g is a feasible circulation of negative cost in the residual graph.

Then $f + g$ is a feasible flow with cost $\text{cost}(f) + \text{cost}(g) < \text{cost}(f)$. Hence, f is not minimum cost.

Lemma 73

A given flow is a mincost-flow if and only if the corresponding residual graph G_f does not have a feasible circulation of negative cost.

⇒ Suppose that g is a feasible circulation of negative cost in the residual graph.

Then $f + g$ is a feasible flow with cost $\text{cost}(f) + \text{cost}(g) < \text{cost}(f)$. Hence, f is not minimum cost.

⇐ Let f be a non-mincost flow, and let f^* be a min-cost flow. We need to show that the residual graph has a feasible circulation with negative cost.

Lemma 73

A given flow is a mincost-flow if and only if the corresponding residual graph G_f does not have a feasible circulation of negative cost.

⇒ Suppose that g is a feasible circulation of negative cost in the residual graph.

Then $f + g$ is a feasible flow with cost $\text{cost}(f) + \text{cost}(g) < \text{cost}(f)$. Hence, f is not minimum cost.

⇐ Let f be a non-mincost flow, and let f^* be a min-cost flow. We need to show that the residual graph has a feasible circulation with negative cost.

Clearly $f^* - f$ is a circulation of negative cost. One can also easily see that it is feasible for the residual graph. (after sending $-f$ in the residual graph (pushing all flow back) we arrive at the original graph; for this f^* is clearly feasible)

10 Mincost Flow

Lemma 74

A graph (without zero-capacity edges) has a feasible circulation of negative cost if and only if it has a negative cycle w.r.t. edge-weights $c : E \rightarrow \mathbb{R}$.

10 Mincost Flow

Lemma 74

A graph (without zero-capacity edges) has a feasible circulation of negative cost if and only if it has a negative cycle w.r.t. edge-weights $c : E \rightarrow \mathbb{R}$.

Proof.

- ▶ Suppose that we have a negative cost circulation.

10 Mincost Flow

Lemma 74

A graph (without zero-capacity edges) has a feasible circulation of negative cost if and only if it has a negative cycle w.r.t. edge-weights $c : E \rightarrow \mathbb{R}$.

Proof.

- ▶ Suppose that we have a negative cost circulation.
- ▶ Find directed cycle only using edges that have non-zero flow.

10 Mincost Flow

Lemma 74

A graph (without zero-capacity edges) has a feasible circulation of negative cost if and only if it has a negative cycle w.r.t. edge-weights $c : E \rightarrow \mathbb{R}$.

Proof.

- ▶ Suppose that we have a negative cost circulation.
- ▶ Find directed cycle only using edges that have non-zero flow.
- ▶ If this cycle has negative cost you are done.

10 Mincost Flow

Lemma 74

A graph (without zero-capacity edges) has a feasible circulation of negative cost if and only if it has a negative cycle w.r.t. edge-weights $c : E \rightarrow \mathbb{R}$.

Proof.

- ▶ Suppose that we have a negative cost circulation.
- ▶ Find directed cycle only using edges that have non-zero flow.
- ▶ If this cycle has negative cost you are done.
- ▶ Otherwise send flow in opposite direction along the cycle until the bottleneck edge(s) does not carry any flow.

10 Mincost Flow

Lemma 74

A graph (without zero-capacity edges) has a feasible circulation of negative cost if and only if it has a negative cycle w.r.t. edge-weights $c : E \rightarrow \mathbb{R}$.

Proof.

- ▶ Suppose that we have a negative cost circulation.
- ▶ Find directed cycle only using edges that have non-zero flow.
- ▶ If this cycle has negative cost you are done.
- ▶ Otherwise send flow in opposite direction along the cycle until the bottleneck edge(s) does not carry any flow.
- ▶ You still have a circulation with negative cost.

10 Mincost Flow

Lemma 74

A graph (without zero-capacity edges) has a feasible circulation of negative cost if and only if it has a negative cycle w.r.t. edge-weights $c : E \rightarrow \mathbb{R}$.

Proof.

- ▶ Suppose that we have a negative cost circulation.
- ▶ Find directed cycle only using edges that have non-zero flow.
- ▶ If this cycle has negative cost you are done.
- ▶ Otherwise send flow in opposite direction along the cycle until the bottleneck edge(s) does not carry any flow.
- ▶ You still have a circulation with negative cost.
- ▶ Repeat.

10 Mincost Flow

Algorithm 45 CycleCanceling($G = (V, E), c, u, b$)

- 1: establish a feasible flow f in G
- 2: **while** G_f contains negative cycle **do**
- 3: use Bellman-Ford to find a negative circuit Z
- 4: $\delta \leftarrow \min\{u_f(e) \mid e \in Z\}$
- 5: augment δ units along Z and update G_f

How do we find the initial feasible flow?

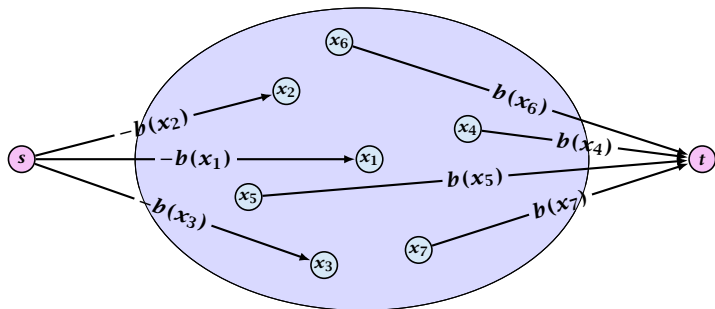

- ▶ Connect new node s to all nodes with negative $b(v)$ -value.
- ▶ Connect nodes with positive $b(v)$ -value to a new node t .
- ▶ There exist a feasible flow in the original graph iff in the resulting graph there exists an s - t flow of value

$$\sum_{v:b(v)<0} (-b(v)) = \sum_{v:b(v)>0} b(v) .$$

10 Mincost Flow

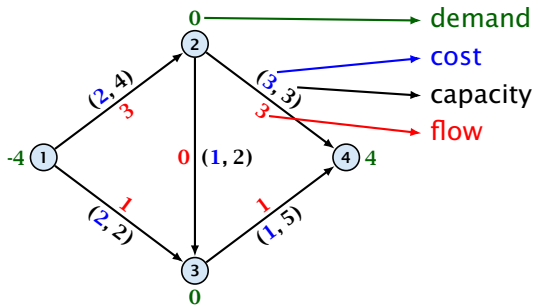

10 Mincost Flow

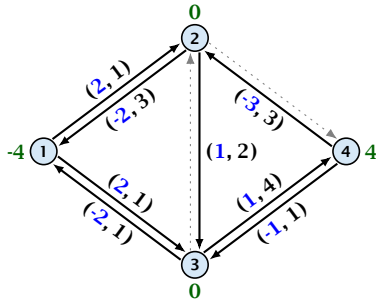

10 Mincost Flow

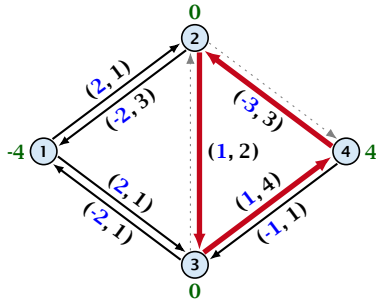

10 Mincost Flow

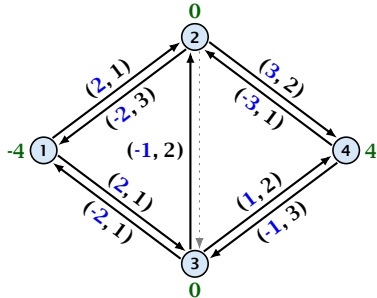

10 Mincost Flow

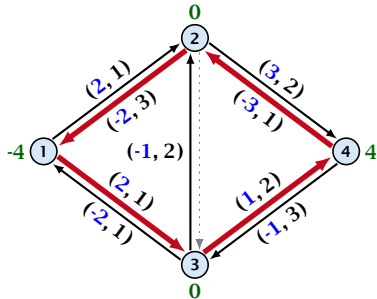

10 Mincost Flow

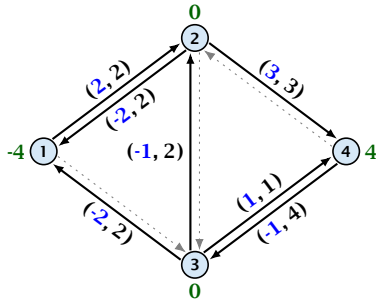

10 Mincost Flow

Lemma 75

The improving cycle algorithm runs in time $\mathcal{O}(nm^2CU)$, for integer capacities and costs, when for all edges e , $|c(e)| \leq C$ and $|u(e)| \leq U$.

- ▶ Running time of Bellman-Ford is $\mathcal{O}(mn)$.
- ▶ Pushing flow along the cycle can be done in time $\mathcal{O}(n)$.
- ▶ Each iteration decreases the total cost by at least 1.
- ▶ The true optimum cost must lie in the interval $[-mCU, \dots, +mCU]$.

Note that this lemma is weak since it does not allow for edges with infinite capacity.

10 Mincost Flow

A **general mincost flow problem** is of the following form:

$$\begin{aligned} \min \quad & \sum_e c(e)f(e) \\ \text{s.t.} \quad & \forall e \in E: \ell(e) \leq f(e) \leq u(e) \\ & \forall v \in V: a(v) \leq f(v) \leq b(v) \end{aligned}$$

where $a: V \rightarrow \mathbb{R}$, $b: V \rightarrow \mathbb{R}$; $\ell: E \rightarrow \mathbb{R} \cup \{-\infty\}$, $u: E \rightarrow \mathbb{R} \cup \{\infty\}$
 $c: E \rightarrow \mathbb{R}$;

Lemma 76 (without proof)

A general mincost flow problem can be solved in polynomial time.